

## Features

- „Easy to Clean“ design based on standard ISO 14 159 und DIN EN 1672-2
- Applications:
  - Machines for food industry
  - Bottling plants
  - Wrapping machines
- Application areas:
  - Interface inside the splash zone
  - Connections with chemical resistance and high cleaning cycles
- Materials und resistance:
  - Housing material with FDA 21 approval
  - Ecolab® tested:
    - P3-topax 52
    - P3-topax 19
    - P3-topax 66
    - P3-topax 99
    - P3-topax 56
    - P3-topax 200
    - P3-topactiv OKTO
  - Acigel, Supergel, Tego 2000

## Technical characteristics

### Hood

Material hood	PP
Material seal outside	EPDM/TPE
Limiting temperatures	-40 °C ... +125 °C
Degree of protection acc. to DIN EN 60 529 locked	IP67 / IP69K
Locking	screw locking

### Inserts

Number of contacts	4/4 + PE
Electrical data acc. to EN 61 984	

#### Power range **16 A 400 V 6 kV 3**

Rated current	16 A
Rated voltage	400 V
Rated impulse voltage	6 kV
Pollution degree	3

#### Control range **10 A 250 V 4 kV 3**

Rated current	10 A
Rated voltage	250 V
Rated impulse voltage	4 kV
Pollution degree	3
Insulation resistance	≥ 10 <sup>10</sup> Ω

Material	PC
Limiting temperatures	-40 °C ... +125 °C
Flammability acc. to UL 94	V 0
Mechanical working life	
- mating cycles	≥ 500



Connector for food industry

Identification	Part number	Drawing	Dimensions in mm
----------------	-------------	---------	------------------

Panel mounted housing straight

with three through holes for fixing screws

09 15 503 0301

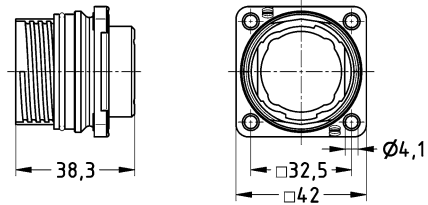

Panel mounted housing angled

with three through holes for fixing screws

09 15 503 0901

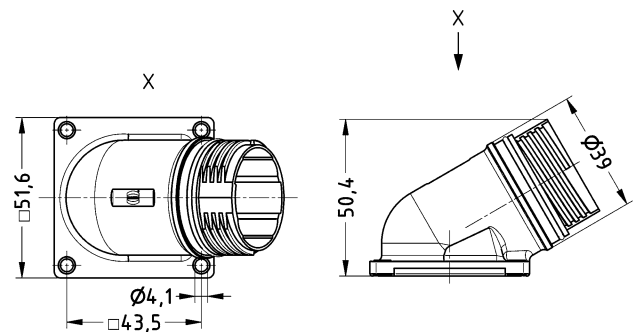

Cover

panel mounted housing

09 15 503 5401

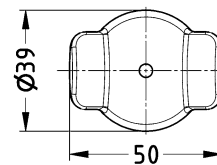

Cover

hood

09 15 503 5411

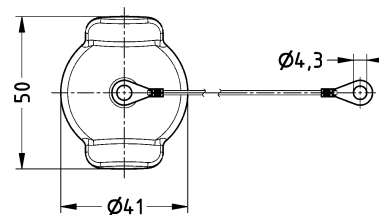

Identification	Part number	Cable entry metric	Drawing	Dimensions in mm
----------------	-------------	--------------------	---------	------------------

Hood

with three through holes for fixing screws

19 15 503 1401

M25

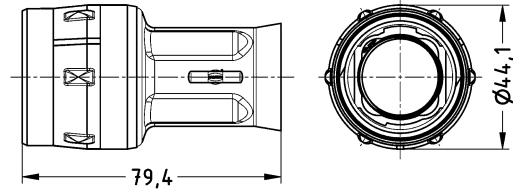

Number of contacts

4 / 4 +

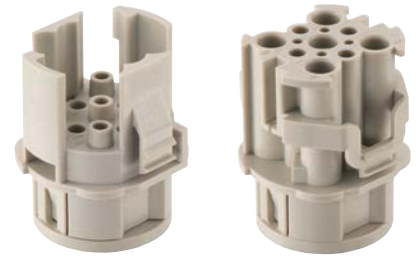

Identification	Part number		Drawing	Dimensions in mm
	Male insert (M)	Female insert (F)		

<p><b>Insulator</b></p> <p>4 contacts 16 A + PE 4 contacts 10 A</p>	09 15 508 3001	09 15 508 3011	<p>M</p> <p>F</p>	
---	----------------	----------------	-------------------	--

Identification	Part number	Drawing	Dimensions in mm
----------------	-------------	---------	------------------













<p><b>Coding pin</b></p> <p>delivery content 20 pieces per bloc</p>	09 12 000 9924		
---	----------------	--	--

<p><b>Contacts</b></p> <p>Han® D and Han® E contacts see catalogue "HARTING Industrial Connectors Han®" chapter 2 und 3</p>			
---	--	--	--

<p><b>Han® 3 A adapter</b></p> <p>for male and female insert series on following page</p>	09 15 503 9911		
---	----------------	--	--











# Summary Han® 3 A for Han® F + B



Series	Han® 3 A	Han® 3 A Quick Lock	Han® 3 A Quick Lock	Han® 4 A
Number of contacts	3 + ⊕	3 + ⊕	3 + ⊕	4 + ⊕
Termination	Screw terminal	Quick Lock terminal	Quick Lock terminal	Screw terminal
				
Rated current	10 A	10 A	10 A	10 A
Rated voltage	230 / 400 V	230 / 400 V	230 / 400 V	230 / 400 V
Wire gauge	1 ... 2.5 mm <sup>2</sup>	0.5 ... 2.5 mm <sup>2</sup>	0.25 ... 1.5 mm <sup>2</sup>	1 ... 2.5 mm <sup>2</sup>
Male insert (M)	09 20 003 2611	09 20 003 2633	09 20 003 2634	09 20 004 2611
Female insert (F)	09 20 003 2711	09 20 003 2733	09 20 003 2734	09 20 004 2711
Series	Han® 4 A Quick Lock	Han® 4 A Quick Lock	Han® 7 D	Han® 7 D Quick Lock
Number of contacts	4 + ⊕	4 + ⊕	7 + ⊕	7 + ⊕
Termination	Quick Lock terminal	Quick Lock terminal	Crimp terminal	Quick Lock terminal
				
Rated current	10 A	10 A	10 A	10 A
Rated voltage	230 / 400 V	230 / 400 V	250 V	250 V
Wire gauge	0.5 ... 2.5 mm <sup>2</sup>	0.25 ... 1.5 mm <sup>2</sup>	0.14 ... 2.5 mm <sup>2</sup>	0.14 ... 2.5 mm <sup>2</sup>
Male insert (M)	09 20 004 2633	09 20 004 2634	09 21 007 3031	09 21 007 2632
Female insert (F)	09 20 004 2733	09 20 004 2734	09 21 007 3131	09 21 007 2732
Series	Han® 8 D	Han® 8 D Quick Lock	Han® Q 2/0	Han® Q 2/0
Number of contacts	8	8	2 + ⊕	2 + ⊕
Termination	Crimp terminal	Quick Lock terminal	Axial screw terminal	Axial screw terminal
				
Rated current	10 A	10 A	40 A	40 A
Rated voltage	~ 50 V / - 120 V	~ 50 V / - 120 V	400 V	400 V
Wire gauge	0.14 ... 2.5 mm <sup>2</sup>	0.25 ... 1.5 mm <sup>2</sup>	2.5 ... 6 mm <sup>2</sup>	4 ... 10 mm <sup>2</sup>
Male insert (M)	09 36 008 3001	09 36 008 2632	09 12 002 2653	09 12 002 2651
Female insert (F)	09 36 008 3101	09 36 008 2732	09 12 002 2753	09 12 002 2751



# Summary Han® 3 A for Han® F + B



Series	Han® Q 2/0	Han® Q 2/0	Han® Q 2/0	Han® Q 2/0
Number of contacts	2 + ⊕	2 + ⊕	2 + ⊕	2 + ⊕
Termination	Crimp terminal 	Axial screw terminal 	Axial screw terminal 	Crimp terminal 
Rated current	40 A	40 A	40 A	40 A
Rated voltage	400 V	830 V	830 V	830 V
Wire gauge	1.5 ... 10 mm <sup>2</sup>	2.5 ... 6 mm <sup>2</sup>	4 ... 10 mm <sup>2</sup>	1.5 ... 10 mm <sup>2</sup>
Male insert (M)	09 12 002 3051	09 12 002 2654	09 12 002 2652	09 12 002 3052
Female insert (F)	09 12 002 3151	09 12 002 2754	09 12 002 2752	09 12 002 3152
Series	Han® Q 3/0	Han® Q 4/0	Han® Q 5/0	Han® Q 5/0 Quick Lock
Number of contacts	3 + ⊕	4	5 + ⊕	5 + ⊕
Termination	Crimp terminal 	Crimp terminal 	Crimp terminal 	Quick Lock terminal 
Rated current	40 A	40 A	16 A	16 A
Rated voltage	400 V	830 V	230 / 400 V	230 / 400 V
Wire gauge	1.5 ... 10 mm <sup>2</sup>	1.5 ... 10 mm <sup>2</sup>	0.14 ... 2.5 mm <sup>2</sup>	0.5 ... 2.5 mm <sup>2</sup>
Male insert (M)	09 12 003 3051	09 12 004 3051	09 12 005 3001	09 12 005 2633
Female insert (F)	09 12 003 3151	09 12 004 3151	09 12 005 3101	09 12 005 2733
Series	Han® Q 7/0	Han® Q 12/0	Han® High Density	
Number of contacts	7 + ⊕	12 + ⊕	21	
Termination	Crimp terminal 	Crimp terminal/ Quick Lock terminal 	Crimp terminal 	
Rated current	10 A	10 A	6.5 A	
Rated voltage	400 V	400 V	~ 50 V / – 120 V	
Wire gauge	0.14 ... 2.5 mm <sup>2</sup>	0.14 ... 2.5 mm <sup>2</sup>	0.09 ... 0.56 mm <sup>2</sup>	
Male insert (M)	09 12 007 3001	09 12 012 3001	09 12 021 3001	
Female insert (F)	09 12 007 3101	09 12 012 3101	09 12 021 3101	

# Summary Han® 3 A for Han® F + B



Series	Han-Brid® RJ45 C	Han-Brid® RJ45 C		
Number of contacts	2 / 8	2 / 8		
Termination	Crimp terminal / RJ45 	Crimp terminal / RJ45 		
Rated current	10 A	10 A		
Rated voltage	24 V	24 V		
Wire gauge	0.14 ... 2.5 mm <sup>2</sup>	0.14 ... 2.5 mm <sup>2</sup>		
Male insert (M)	09 12 003 3021	09 12 003 3031		
Female insert (F)				